

# 9111 Series

## Hard Metric Connector Female Right Angle Type E

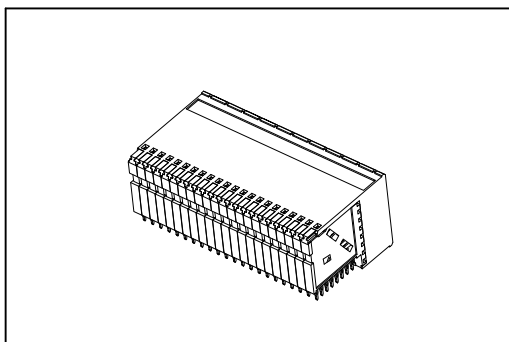

### Material:

Housing: Thermoplastic Polyester Glass Filled UL94V-0.  
Contacts: Copper Alloy.

### Electrical Characteristics:

Current Rating : 1 A.  
Dielectric Withstanding Voltage: AC 750V.  
Insulator Resistance: 10000M $\Omega$  min.  
Contact Resistance: 20m $\Omega$  max.  
Operating Temperature: -55 $^{\circ}$ C ~+125  $^{\circ}$ C.

### Features:

\* Type E Right Angle Female.  
8 X 25 Position Fully Loaded.

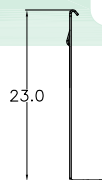
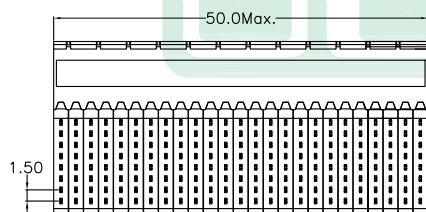
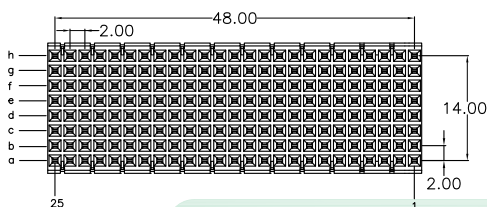

Bottom Shielded

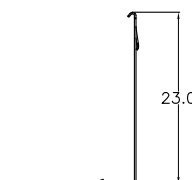
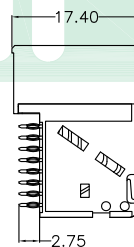

Top Shielded

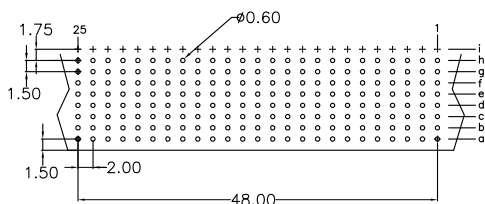

P.C. Board Layout

## Ordering information

9111- Series	10 10Row	2 2: Female	E E: Type E	200 Position	1 1: None Shielded 2: Top Body Shielded 3: Top Body Shielded and Bottom Shielded (Package Separately)	CB CB:Contact Au+Pd/Ni, Dip Tin plated	30 30: 30 $\mu$ "	A A: Tray Package
-----------------	-------------	----------------	----------------	-----------------	--	---	----------------------	-------------------------